

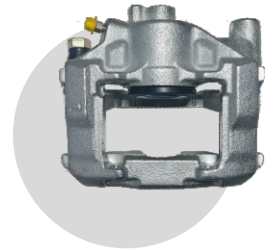

和茂<sup>®</sup>  
茂德盛<sup>®</sup>



# *BRAKE CALIPER*

## *CLUTCH COVER*

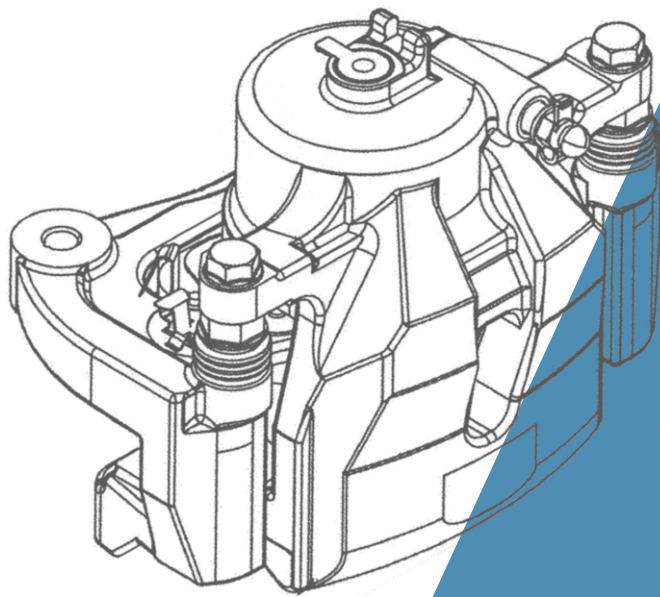

### Products Series

- Brake Caliper
- Repair Kits
- Metal Pistons
- Clutch Cover



玉环和茂汽车配件有限公司  
YUHUAN HEMA0 AUTO PARTS CO.,LTD.

# 关于我们

玉环和茂汽车配件有限公司创建于2011年，是一家专业生产销售汽车制动钳总成、离合器盖、离合器盘总成的企业。公司坐落于中国汽车零部件产业基地——浙江玉环。

我们公司凭着“质量第一，顾客第一，严格管理，追求卓越”的信念，积极与国内外客户建立友好互利、真挚长久的合作关系。



## 选择我们的理由

诚信经营

用心服务

产品生产前经过反复多次的可行性试验，拥有一套先进的质量检测系统，出厂前需经过多项质量检测。

高精生产



优质材料



选择优质材料进行生产加工，同时针对一系列配套都有严格标准的测试要求。

工作流程明确规范。每一步都有专人全程跟踪落实，员工上岗需要经过专业的流程培训。

流程完善



实力强大



和多家企业长期合作，拥有多种进口设备，定期培训教育工作人员。

因为专业

所以卓越

# About us

**Yuhuan hemao Auto Parts Co., Ltd.**, founded in 2011, is a company specializing in the production and sale of automobile clutch covers, clutch disc assembly and brake caliper assembly. The company is located in China's auto parts industry base, Yuhuan, Zhejiang.

With the belief of quality first, customer first, strict management and excellence, our company is actively establishing friendly, mutually beneficial and sincere long-term cooperation with domestic and foreign customers.

# BRAKE CALIPER MANUFACTURER



## WHY CHOOSE US

Integrity management

Serves attentively

- **High precision production**

After repeated feasibility tests before production, we have a set of advanced quality inspection system, and need to pass a number of quality tests before leaving the factory.



- **High quality material**

Select high quality materials for production and processing, at the same time for a series of supporting have strict test standards.

- **Good manufacturing practice**

The work flow is clear and standardized. Every step is followed up by special personnel, and employees need to go through professional process training.



- **Strong enterprise strength**

Established long-term cooperation with a number of enterprises, with a variety of imported equipment, regular training for employee.

**Prominence comes from professional.**



玉环和茂汽车配件有限公司  
YUHUAN HEMAO AUTO PARTS CO.,LTD.



**Quality**

**is the eternal soul of an**

**enterprise**

HEMAO

质量是企业永恒的灵魂

# CONTENTS

)	<b>BYD</b>	<b>比亚迪系列</b>	<b>1-2</b>
	CHERY	奇瑞系列	3-4
)	<b>GEELY AUTO</b>	<b>吉利系列</b>	<b>5-6</b>
	TOYOTA	丰田系列	7
)	<b>JAC Motors</b>	<b>江淮系列</b>	<b>8</b>
	SUZUKI	铃木系列	9
)	<b>ROEWE</b>	<b>荣威系列</b>	<b>10</b>
	SGMW	五菱系列	11-12
)	<b>XIALI</b>	<b>夏利系列</b>	<b>13</b>
	HYUNDAI	现代系列	14-15
)	<b>CHANGAN</b>	<b>长安系列</b>	<b>16-18</b>
	DFM	东风系列	19
)	<b>GREAT WALL</b>	<b>长城系列</b>	<b>20</b>
	MAZDA	马自达系列	21
)	<b>HONDA</b>	<b>本田系列</b>	<b>22</b>
	GAC Motor	广汽传祺系列	23
)	<b>VW</b>	<b>大众系列</b>	<b>24</b>
	BUICK	别克系列	25-26
)	<b>OTHER</b>	<b>其他系列</b>	<b>27</b>
	REPAIR KITS	制动钳维修包	28
)	<b>CLUTCH COVER</b>	<b>离合器盖总成</b>	<b>29-30</b>
)			
)			

	HM-001	
	OE No.	10921389-00 10921390-00
	Model	S6前分泵 万向款
	Description	

	HM-002	
	OE No.	11632957-00 10921397-00
	Model	S6后分泵 万向款
	Description	

	HM-003	
	OE No.	10921393-00 10921394-00
	Model	S6前分泵 博士款
	Description	

	HM-004	
	OE No.	10409652-00 10409653-00
	Model	S6后分泵 博士款
	Description	

	HM-005	
	OE No.	10486644-00 10486645-00
	Model	速锐前分泵 博士款
	Description	

	HM-006	
	OE No.	10992666-00 10987589-00
	Model	速锐后分泵 博士款
	Description	

	HM-007	
	OE No.	11071452-00 11071453-00
	Model	速锐前分泵 万向款
	Description	

	HM-008	
	OE No.	10992665-00 10987580-00
	Model	速锐后分泵 万向款
	Description	机械手刹

	HM-009	
	OE No.	10992664-00 10987579-00
	Model	速锐后分泵 万向款
	Description	电子手刹

	HM-010	
	OE No.	1014011066-01 1014011067-01
	Model	F0前分泵
	Description	

	HM-011	
	OE No.	10247656-00 10247657-00
	Model	F3前分泵
	Description	

	HM-012	
	OE No.	10247658-00 10247659-00
	Model	F3后分泵
	Description	

	HM-013	
	OE No.	10199960-00 10199959-00
	Model	F6后分泵
	Description	

	HM-014	
	OE No.	10554342-00 10554343-00
	Model	G6后分泵
	Description	

<p>暂无图片</p>	HM-149	
	OE No.	/
	Model	宋MAX前分泵
	Description	

<p>暂无图片</p>	HM-150	
	OE No.	/
	Model	宋MAX后分泵
	Description	

<p>暂无图片</p>	HM-151	
	OE No.	/
	Model	秦PRO前分泵
	Description	新款

<p>暂无图片</p>	HM-152	
	OE No.	/
	Model	秦PRO后分泵
	Description	

<p>暂无图片</p>	HM-153	
	OE No.	/
	Model	E5前分泵
	Description	

<p>暂无图片</p>	HM-154	
	OE No.	/
	Model	E5后分泵
	Description	

	HM-015	
	OE No.	T11-3502050 T11-3502060
	Model	瑞虎后分泵 老款
	Description	

	HM-016	
	OE No.	T11-3501050 T11-3501060
	Model	瑞虎前分泵 老款
	Description	

	HM-017	
	OE No.	A21-3501050 A21-3501060
	Model	A5前分泵
	Description	

	HM-018	
	OE No.	A21-3502050 A21-3502060
	Model	A5后分泵
	Description	

	HM-019	
	OE No.	S11-3501050 S11-3501060
	Model	QQ前分泵
	Description	

	HM-020	
	OE No.	A11-6GN3501050AB A11-6GN3501060AB
	Model	旗云前分泵
	Description	

	HM-021	
	OE No.	T11-6GB3502050BA T11-6GB3502060BA
	Model	瑞虎后分泵 新款
	Description	

	HM-022	
	OE No.	T11-3501050BA T11-3501060BA
	Model	瑞虎前分泵 新款
	Description	

	HM-023	
	OE No.	S21-6GN3501050 S21-6GN3501020
	Model	QQ6前分泵 新款
	Description	

	HM-024	
	OE No.	S21-3501050 S21-3501060
	Model	QQ6前分泵 老款
	Description	



	HM-025	
	OE No.	A11-3501050AB A11-3501060AB
	Model	风云前分泵
	Description	

<p>暂无图片</p>	HM-155	
	OE No.	/
	Model	艾瑞泽5前分泵
	Description	

<p>暂无图片</p>	HM-156	
	OE No.	/
	Model	艾瑞泽5后分泵
Description		

<p>暂无图片</p>	HM-157	
	OE No.	/
	Model	E3前分泵
Description		

<p>暂无图片</p>	HM-158	
	OE No.	/
	Model	小蚂蚁前分泵
Description		

<p>暂无图片</p>	HM-159	
	OE No.	/
	Model	eQ前分泵
Description		

<p>暂无图片</p>	HM-161	
	OE No.	/
	Model	艾瑞泽GX前分泵
Description		

<p>暂无图片</p>	HM-162	
	OE No.	/
	Model	艾瑞泽GX后分泵
Description		

	HM-026	
	OE No.	1014011605 1014011606
	Model	帝豪EC8 前分泵
	Description	

	HM-027	
	OE No.	1014014187 1014014188
	Model	帝豪EC8 后分泵
	Description	

	HM-028	
	OE No.	101402550951 101402551051
	Model	GX7前分泵 博士款
	Description	

	HM-029	
	OE No.	1014013382 1014013383
	Model	GX7后分泵 博士款
	Description	

	HM-030	
	OE No.	1064001720 1064001721
	Model	帝豪EC7 前分泵博士款
	Description	

	HM-031	
	OE No.	1064001722 1064001723
	Model	帝豪EC7 后分泵博士款
	Description	

	HM-032	
	OE No.	1014001809 1014001810
	Model	金刚前分泵
	Description	

	HM-033	
	OE No.	1014011066-01 1014011067-01
	Model	熊猫前分泵
	Description	

	HM-034	
	OE No.	3501102180-01 3501202180-01
	Model	优利欧 前分泵
	Description	

	HM-035	
	OE No.	1061001402 1061001403
	Model	远景前分泵
	Description	

	HM-036	
	OE No.	1061001405 1061001406
	Model	远景后分泵
	Description	

	HM-037	
	OE No.	3501102180 3501202180
	Model	自由舰前分泵 加大款
	Description	

	HM-039	
	OE No.	1402136180 1402137180
	Model	自由舰前分泵 普通款
	Description	

<p>暂无图片</p>	HM-144	
	OE No.	/
	Model	博越前分泵
	Description	

<p>暂无图片</p>	HM-145	
	OE No.	/
	Model	帝豪GS 后分泵
	Description	

<p>暂无图片</p>	HM-146	
	OE No.	/
	Model	远景X3 前分泵
	Description	

<p>暂无图片</p>	HM-147	
	OE No.	/
	Model	帝豪GL 前分泵
	Description	

<p>暂无图片</p>	HM-148	
	OE No.	/
	Model	远景X6 前分泵
	Description	

<p>暂无图片</p>	HM-198	
	OE No.	/
	Model	博瑞前分泵
	Description	

<p>暂无图片</p>	HM-199	
	OE No.	/
	Model	博瑞后分泵
	Description	

	HM-040	
	OE No.	47850-42061 47830-42061
	Model	RAV4后分泵
	Description	

	HM-041	
	OE No.	47750-0k140 47730-0k140
	Model	海拉克斯前分泵
	Description	

	HM-042	
	OE No.	47850-0E030 47830-0E030
	Model	汉兰达后分泵
	Description	

	HM-043	
	OE No.	47850-02160 47830-02160
	Model	卡罗拉后分泵
	Description	

	HM-044	
	OE No.	47750-06270 47730-06270
	Model	凯美瑞前分泵
	Description	

	HM-045	
	OE No.	47850-33210 47830-33210
	Model	凯美瑞后分泵
	Description	

	HM-046	
	OE No.	47730-0N010 47750-0N010
	Model	锐志前分泵
	Description	

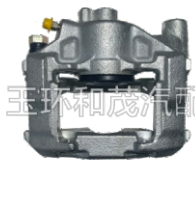
	HM-047	
	OE No.	47830-0N010 47850-0N010
	Model	锐志后分泵
	Description	

	HM-048	
	OE No.	47750-0k061 47730-0k061
	Model	海拉克斯前分泵
	Description	四驱版

	HM-038	
	OE No.	47730-02390 47750-02390
	Model	卡罗拉前分泵
	Description	

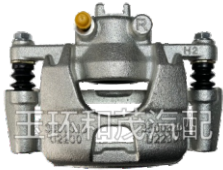
	HM-049	
	OE No.	3503100U2230 3503200U2230
	Model	S3前分泵
	Description	

	HM-050	
	OE No.	3500700U2230 3500800U2230
	Model	S3后分泵
	Description	

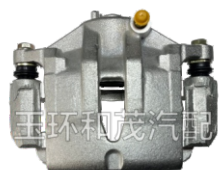
	HM-051	
	OE No.	3503100U1520 3503200U1520
	Model	S5前分泵
	Description	

	HM-052	
	OE No.	3504100U1510 3504200U1510
	Model	S5后分泵
	Description	

	HM-053	
	OE No.	3500310U8510 3500320U8510
	Model	和悦A30 前分泵
	Description	

	HM-054	
	OE No.	58180-4AA00 58190-4AA00
	Model	瑞风商务车 前分泵
	Description	

	HM-055	
	OE No.	3500190U2010 3500160U2010
	Model	和悦前分泵
	Description	

	HM-056	
	OE No.	3500250U2010 3500220U2010
	Model	和悦后分泵
	Description	

	HM-057	
	OE No.	3501017U8050 3501027U8050
	Model	悦悦前分泵
	Description	

	HM-058	
	OE No.	/
	Model	1018前分泵
Description		

	HM-059	
	OE No.	/
	Model	奥拓前分泵
Description		

	HM-060	
	OE No.	/
	Model	北斗星前分泵
Description		

	HM-061	
	OE No.	/
	Model	福瑞达前分泵
Description		

	HM-062	
	OE No.	/
	Model	民意前分泵
Description		

	HM-063	
	OE No.	/
	Model	雨燕前分泵
Description		

	HM-064	
	OE No.	/
	Model	中意前分泵
Description		

	HM-065	
	OE No.	10030669 10030885
	Model	荣威350 前分泵
	Description	

	HM-066	
	OE No.	10112588 10112589
	Model	荣威350 后分泵
	Description	

	HM-067	
	OE No.	10068464 10068465
	Model	荣威550 前分泵
	Description	

	HM-068	
	OE No.	30000118 30000120
	Model	荣威550 后分泵
	Description	

<p>暂无图片</p>	HM-163	
	OE No.	/
	Model	荣威RX5 前分泵
	Description	

<p>暂无图片</p>	HM-164	
	OE No.	/
	Model	荣威RX5 后分泵
	Description	

<p>暂无图片</p>	HM-165	
	OE No.	/
	Model	荣威Ei5 前分泵
	Description	

<p>暂无图片</p>	HM-166	
	OE No.	/
	Model	荣威Ei5 后分泵
	Description	

<p>暂无图片</p>	HM-167	
	OE No.	/
	Model	荣威i5 前分泵
	Description	

<p>暂无图片</p>	HM-168	
	OE No.	/
	Model	荣威i5 后分泵
	Description	

	HM-069	
	OE No.	6360-3501013 6360-3501014
	Model	6360前分泵
	Description	

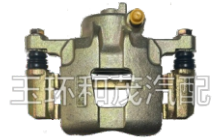
	HM-070	
	OE No.	24549164 24549165
	Model	SPK前分泵
	Description	

	HM-071	
	OE No.	23626273 23626274
	Model	宝骏560 后分泵
	Description	

	HM-072	
	OE No.	26263444 26263445
	Model	宝骏630 前分泵
	Description	

	HM-073	
	OE No.	23626955 24566104
	Model	宝骏730 前分泵
	Description	

	HM-074	
	OE No.	23626273 23626274
	Model	宝骏730 后分泵
	Description	

	HM-075	
	OE No.	23971428 23971429
	Model	宏光前分泵
	Description	

	HM-076	
	OE No.	23748443 23748442
	Model	宏光Mini 前分泵
	Description	

	HM-077	
	OE No.	23948521 23948522
	Model	荣光前分泵
	Description	

	HM-078	
	OE No.	23640746 23640747
	Model	荣光S前分泵
	Description	



	HM-079	
	OE No.	P4101-10031 P4101-10032
	Model	小旋风 前分泵
	Description	

	HM-080	
	OE No.	23972887 23972889
	Model	之光前分泵
	Description	

	HM-140	
	OE No.	/
	Model	宝骏630 后分泵
	Description	

	HM-141	
	OE No.	/
	Model	宝骏630 新款前分泵
	Description	

<p>暂无图片</p>	HM-136	
	OE No.	/
	Model	宝骏E200 后分泵
	Description	

<p>暂无图片</p>	HM-137	
	OE No.	/
	Model	宝骏530 前分泵
	Description	

<p>暂无图片</p>	HM-138	
	OE No.	/
	Model	宝骏510 前分泵
	Description	

<p>暂无图片</p>	HM-139	
	OE No.	/
	Model	宝骏510 后分泵
	Description	

<p>暂无图片</p>	HM-142	
	OE No.	/
	Model	宝骏360 后分泵
	Description	

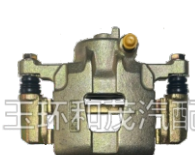
	HM-081	
	OE No.	/
	Model	2000 前分泵
Description		

	HM-082	
	OE No.	/
	Model	威志前分泵
Description		

	HM-083	
	OE No.	/
	Model	花冠前分泵
Description		

	HM-084	
	OE No.	/
	Model	花冠后分泵
Description		

	HM-085	
	OE No.	/
	Model	夏利三缸 前分泵
Description		

	HM-086	
	OE No.	/
	Model	夏利四缸 后分泵
Description		

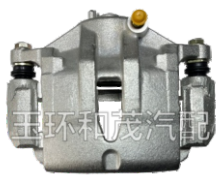
	HM-087	
	OE No.	58180-2SA70 58190-2SA70
	Model	IX35前分泵
	Description	

	HM-088	
	OE No.	58310-2ZA20 58311-2ZA20
	Model	IX35后分泵
	Description	

	HM-089	
	OE No.	58180-OUA10 58190-OUA10
	Model	瑞纳前分泵
	Description	

	HM-090	
	OE No.	58110-4Q000 58130-4Q000
	Model	索纳塔前分泵
	Description	

	HM-091	
	OE No.	58210-4Q000 58230-4Q000
	Model	索纳塔后分泵
	Description	

	HM-092	
	OE No.	58180-1GA00 58190-1GA00
	Model	雅绅特前分泵
	Description	

	HM-093	
	OE No.	58310-0M300 58410-0M300
	Model	雅绅特后分泵
	Description	

	HM-094	
	OE No.	58310-2DA20 58190-2SA70
	Model	伊兰特后分泵
	Description	老款

	HM-095	
	OE No.	58310-2DA30 58311-2DA30
	Model	伊兰特后分泵
	Description	新款

	HM-096	
	OE No.	58180-2DA10 58190-2DA10
	Model	伊兰特前分泵
	Description	

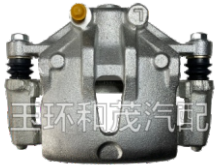
	HM-097	
	OE No.	58110-0Q000 58210-0Q000
	Model	悦动前分泵
	Description	

	HM-098	
	OE No.	58210-0Q300 58230-0Q300
	Model	悦动后分泵
	Description	

暂无图片	HM-169	
	OE No.	/
	Model	朗动前分泵
	Description	

暂无图片	HM-170	
	OE No.	/
	Model	朗动后分泵
	Description	

暂无图片	HM-171	
	OE No.	/
	Model	名图前分泵
	Description	

暂无图片	HM-172	
	OE No.	/
	Model	名图后分泵
	Description	

暂无图片	HM-173	
	OE No.	/
	Model	领动前分泵
	Description	新款

暂无图片	HM-174	
	OE No.	/
	Model	领动后分泵
	Description	新款

	HM-175	
	OE No.	/
	Model	途胜前分泵
	Description	

	HM-176	
	OE No.	/
	Model	途胜后分泵
	Description	

	HM-099	
	OE No.	/
	Model	1026前分泵
	Description	

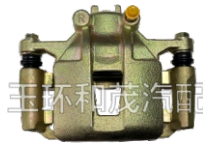
	HM-100	
	OE No.	3501110-J01 3501210-J01
	Model	4500前分泵
	Description	

	HM-101	
	OE No.	S101062-0100 S101062-0101
	Model	CS35前分泵
	Description	

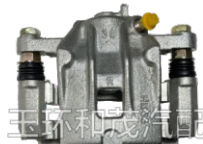
	HM-102	
	OE No.	S101063-0100 S101063-0101
	Model	CS35后分泵
	Description	

	HM-103	
	OE No.	3501132 3501232
	Model	CS75前分泵
	Description	

	HM-104	
	OE No.	3508511 3508521
	Model	CS75后分泵
	Description	

	HM-105	
	OE No.	/
	Model	CS75后分泵
	Description	新款

	HM-106	
	OE No.	3501130-BB01 3501230-BB01
	Model	Cx70前分泵
	Description	

	HM-107	
	OE No.	3502100-BB02 3502200-BB02
	Model	CX70后分泵
	Description	

	HM-108	
	OE No.	/
	Model	S460前分泵
	Description	

	HM-109	
	OE No.	/
	Model	二代6399 前分泵
Description		

	HM-110	
	OE No.	/
	Model	二代CM5 前分泵
Description		

	HM-111	
	OE No.	3501110-T01 3501210-T01
	Model	欧诺前分泵
Description		

	HM-112	
	OE No.	/
	Model	神骐前分泵
Description		

	HM-113	
	OE No.	L0300060038A0-34-10 L0300060038A0-35-10
	Model	神骐前分泵
Description		专用款

	HM-114	
	OE No.	3501110-Y301 3501210-Y301
	Model	小货S201 前分泵
Description		

	HM-115	
	OE No.	/
	Model	新之星M201 前分泵
Description		

	HM-116	
	OE No.	3501110-01 3501210-01
	Model	之星前分泵
Description		

	HM-117	
	OE No.	3501110-U02 3501210-U02
	Model	逸动前分泵
Description		

	HM-118	
	OE No.	3502110-U02 3502210-U02
	Model	逸动后分泵
Description		

	<b>HM-119</b>	
	OE No.	/
	Model	二代前分泵
	Description	老款

<p>暂无图片</p>	<b>HM-177</b>	
	OE No.	/
	Model	悦翔V7前分泵
	Description	

<p>暂无图片</p>	<b>HM-178</b>	
	OE No.	/
	Model	悦翔V7后分泵
	Description	

<p>暂无图片</p>	<b>HM-179</b>	
	OE No.	/
	Model	奔奔MINI前分泵
	Description	

<p>暂无图片</p>	<b>HM-180</b>	
	OE No.	/
	Model	CS15前分泵
	Description	

<p>暂无图片</p>	<b>HM-181</b>	
	OE No.	/
	Model	欧尚前分泵
	Description	

<p>暂无图片</p>	<b>HM-182</b>	
	OE No.	/
	Model	欧尚后分泵
	Description	

<p>暂无图片</p>	<b>HM-183</b>	
	OE No.	/
	Model	CS55前分泵
	Description	

<p>暂无图片</p>	<b>HM-184</b>	
	OE No.	/
	Model	CS55后分泵
	Description	

	<b>HM-197</b>	
	OE No.	/
	Model	CX20前分泵
	Description	

	HM-120	
	OE No.	/
	Model	风光330 前分泵
	Description	

	HM-121	
	OE No.	3501470-FB01 3501480-FB01
	Model	风光360 前分泵
	Description	

暂无图片	HM-122	
	OE No.	/
	Model	风光360 后分泵
	Description	

	HM-123	
	OE No.	3501470-SA01 3501480-SA01
	Model	风光370 前分泵
	Description	

暂无图片	HM-124	
	OE No.	/
	Model	风光370 后分泵
	Description	

	HM-125	
	OE No.	/
	Model	风光580 前分泵
	Description	

	HM-126	
	OE No.	/
	Model	小康V27 前分泵
	Description	



	HM-127	
	OE No.	/
	Model	C30后分泵
	Description	

	HM-128	
	OE No.	3502100-K00 3502200-K00
	Model	哈弗后分泵
	Description	

<p>暂无图片</p>	HM-185	
	OE No.	/
	Model	C30前分泵
	Description	

<p>暂无图片</p>	HM-186	
	OE No.	/
	Model	C50前分泵
	Description	

<p>暂无图片</p>	HM-187	
	OE No.	/
	Model	C50后分泵
	Description	

	HM-188	
	OE No.	/
	Model	哈弗H6前分泵
	Description	

<p>暂无图片</p>	HM-189	
	OE No.	/
	Model	哈弗H6后分泵
	Description	

<p>暂无图片</p>	HM-190	
	OE No.	/
	Model	哈弗H2前分泵
	Description	

<p>暂无图片</p>	HM-218	
	OE No.	/
	Model	哈弗H2后分泵
	Description	

	HM-129	
	OE No.	/
	Model	福美莱前分泵
Description		

	HM-130	
	OE No.	/
	Model	福美莱后分泵
Description		

暂无图片	HM-191	
	OE No.	/
	Model	CX-5前分泵
Description		

暂无图片	HM-192	
	OE No.	/
	Model	CX-5后分泵
Description		

暂无图片	HM-193	
	OE No.	/
	Model	马自达3昂克赛拉前分泵
Description		

暂无图片	HM-194	
	OE No.	/
	Model	马自达3昂克赛拉后分泵
Description		

暂无图片	HM-216	
	OE No.	/
	Model	马自达3前分泵
Description		

暂无图片	HM-217	
	OE No.	/
	Model	马自达3后分泵
Description		

暂无图片	HM-245	
	OE No.	/
	Model	马自达6前分泵
Description		

	HM-246	
	OE No.	/
	Model	马自达6后分泵
Description		

暂无图片	HM-202	
	OE No.	45019-SDD-A00 45018-SDD-A00
	Model	雅阁2.4 前分泵
	Description	

	HM-203	
	OE No.	43019-SDC-A00 43018-SDC-A00
	Model	雅阁2.4 后分泵
	Description	

暂无图片	HM-204	
	OE No.	45019-SWA 45018-SWA
	Model	本田CRV 前分泵
	Description	

暂无图片	HM-205	
	OE No.	43019-SWA 43018-SWA
	Model	本田CRV 后分泵
	Description	

暂无图片	HM-206	
	OE No.	45019-TBO-W00 45018-TBO-W00
	Model	雅阁08款 前分泵
	Description	

暂无图片	HM-207	
	OE No.	43019-TA0-003 43018-TA0-003
	Model	雅阁08款 后分泵
	Description	

暂无图片	HM-208	
	OE No.	45019-SNV 45018-SNV
	Model	思域06款 前分泵
	Description	

暂无图片	HM-209	
	OE No.	43019-SNA-A10 43018-SNA-A10
	Model	思域06款 后分泵
	Description	

暂无图片	HM-210	
	OE No.	45019-SAA-900 45018-SAA-900
	Model	飞度老款 前分泵
	Description	

暂无图片	HM-211	
	OE No.	45019-TGS 45018-TGS
	Model	飞度08-13 前分泵
	Description	

	HM-219	
	OE No.	3510001ADE0000 /
	Model	GM6前分泵
	Description	

暂无图片	HM-220	
	OE No.	/
	Model	GM6后分泵
	Description	

	HM-221	
	OE No.	3510001CAD0000 /
	Model	GM8前分泵
	Description	

暂无图片	HM-222	
	OE No.	/
	Model	GM8后分泵
	Description	

	HM-223	
	OE No.	3510001ASV0000 /
	Model	GS4前分泵
	Description	

暂无图片	HM-224	
	OE No.	/
	Model	GS4后分泵
	Description	

	HM-225	
	OE No.	3510001BAD0000 /
	Model	GS5前分泵
	Description	

暂无图片	HM-226	
	OE No.	/
	Model	GS5后分泵
	Description	

	HM-227	
	OE No.	3510001CAD0000 /
	Model	GS8前分泵
	Description	

暂无图片	HM-228	
	OE No.	/
	Model	GS8后分泵
	Description	

 <p>玉环和茂汽配</p>	HM-247	
	OE No.	/
	Model	宝来前分泵
Description		

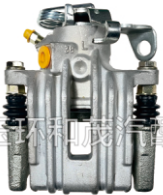
 <p>玉环和茂汽配</p>	HM-248	
	OE No.	/
	Model	宝来后分泵
Description		

 <p>玉环和茂汽配</p>	HM-249	
	OE No.	/
	Model	B5后分泵
Description		

<p>暂无图片</p>	HM-250	
	OE No.	/
	Model	速腾前分泵
Description		

 <p>玉环和茂汽配</p>	HM-251	
	OE No.	/
	Model	速腾后分泵
Description		

<p>暂无图片</p>	HM-255	
	OE No.	/
	Model	迈腾前分泵
Description		

<p>暂无图片</p>	HM-256	
	OE No.	/
	Model	迈腾后分泵
Description		

	HM-229	
	OE No.	/
	Model	凱越前分泵
	Description	

	HM-230	
	OE No.	/
	Model	凱越后分泵
	Description	

	HM-231	
	OE No.	/
	Model	新凱越前分泵
	Description	

	HM-232	
	OE No.	/
	Model	新君威后分泵电动
	Description	

	HM-233	
	OE No.	/
	Model	新君威后分泵手动
	Description	

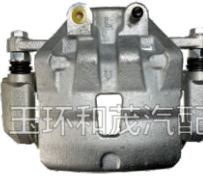
	HM-234	
	OE No.	/
	Model	新君越前分泵
	Description	

	HM-235	
	OE No.	/
	Model	新君越后分泵
	Description	

	HM-236	
	OE No.	/
	Model	昂科拉前分泵
	Description	

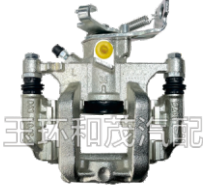
	HM-237	
	OE No.	/
	Model	昂科拉后分泵
	Description	

	HM-238	
	OE No.	/
	Model	老君越后分泵
	Description	

	HM-239	
	OE No.	/
	Model	15英朗后分泵
Description		

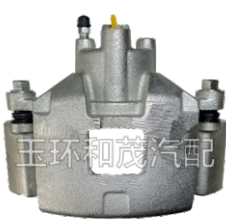
	HM-240	
	OE No.	/
	Model	陆尊前分泵
Description		

	HM-241	
	OE No.	/
	Model	陆尊后分泵
Description		

	HM-242	
	OE No.	/
	Model	新陆尊后分泵
Description		

	HM-243	
	OE No.	/
	Model	07-14款英朗前分泵
Description		

	HM-244	
	OE No.	/
	Model	07-14款英朗后分泵
Description		

	HM-131	
	OE No.	/
	Model	力帆320 前分泵
	Description	力帆

	HM-132	
	OE No.	/
	Model	力帆620 前分泵
	Description	力帆

	HM-133	
	OE No.	/
	Model	力帆620 后分泵
	Description	力帆

	HM-134	
	OE No.	S3501200 S3501700
	Model	力帆X60 前分泵
	Description	力帆

	HM-135	
	OE No.	S3502200 S3502700
	Model	力帆X60 后分泵
	Description	力帆

暂无图片	HM-252	
	OE No.	/
	Model	新菱帅 后分泵
	Description	东南

	HM-254	
	OE No.	/
	Model	科鲁兹 前分泵
	Description	雪佛兰

	HM-253	
	OE No.	/
	Model	科鲁兹 后分泵
	Description	雪佛兰



# REPAIR KITS

## 制动钳维修包



# CLUTCH COVER

## 离合器盖总成

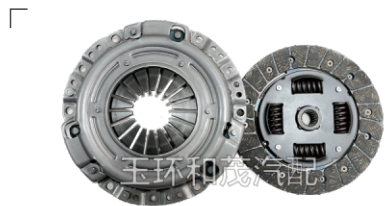

**B12加大** 188×126  
188×130-18

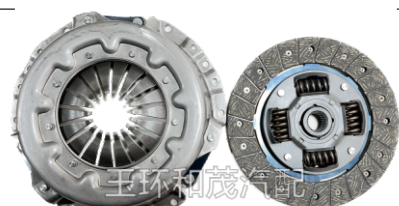

**荣光1.5** 225×154  
225×155-23



**宏光1.2** 190×126  
188×130-18

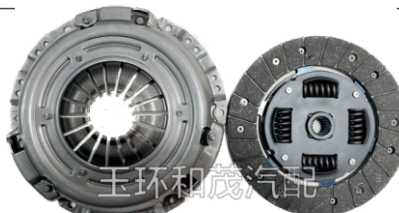

**宏光1.4** 200×133  
200×137-18



**宏光1.5** 215×142  
215×145-24



**465Q铃木** 180×120  
180×125-18



**368Q** 160×108  
160×110-32



**羚羊474Q1** 190×126  
190×132-18



**372Q** 180×108  
180×125-18



**465Q4** 180×108  
180×125-18



**474Q** 190×126  
190×132-18



**473Q** 200×126  
200×134-20

# CLUTCH COVER

## 离合器盖总成



比亚迪F3

200×129  
200×134-20

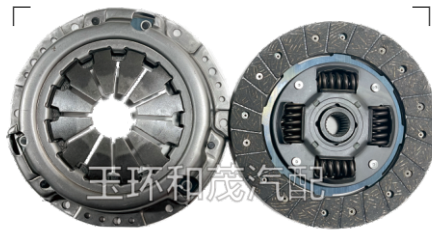

比亚迪473

200×128  
200×134-20



比亚迪F6

215×138  
215×140-20



8A

180×122  
180×125-20

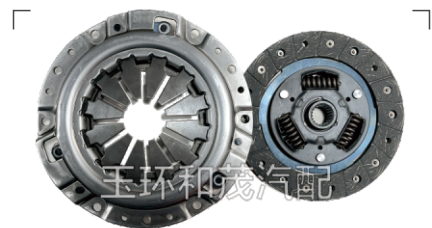

N3+

180×108  
180×125-20



N5

200×128  
200×134-19

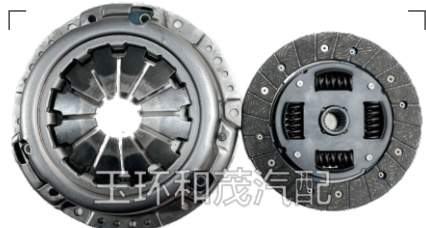

吉利479Q

190×126  
188×130-20

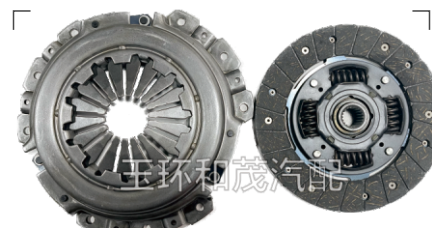

金刚481

200×129  
200×134-20

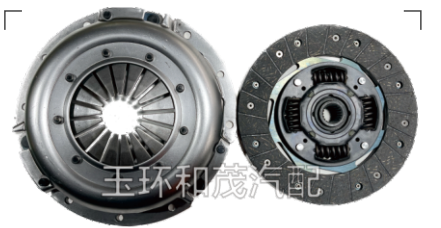

吉利远景

210×138  
210×140-20

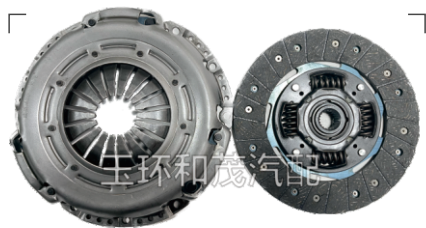

威旺M20

215×148  
215×148-20



北汽幻速

200×126  
200×134-20

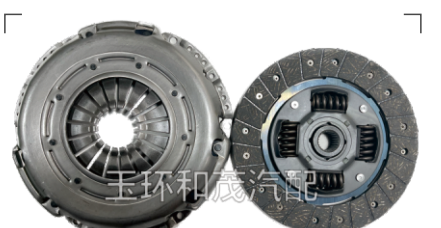

宝骏730

225×148  
225×155-23

**玉环和茂汽车配件有限公司**  
YUHUAN HEMA0 AUTO PARTS CO.,LTD.

地址：浙江省玉环市坎门海洋经济转型示范区

ADD: Demonstration area of marine economic transformation  
kanmen yuhuan,Zhejiang,China

电话/TEL: +86-13706868356

Web: [www.yhhemao.com](http://www.yhhemao.com)

E-mail: [2011hemao@gmail.com](mailto:2011hemao@gmail.com)

